

Screeding with Probst.
Clever, effective and workable.



Expertise | Quality | Innovation | Service

Finding the right basis on each site - Probst Screeding Solutions.

The correct height counts!

Before laying blocks the foundation needs to be created. The handling and laying specialists of Probst have invented a wide program of screeding systems to match any application regardless of size and complexity. As usual Probst screeding systems help to make your work easier, comfortable

and more profitable. Our intention is always to offer the right system for the individual requirements of our customers. Have a look at our screeding program and get an impression of the possible variations. From the specialist for the specialist.

SCREEDING

Screeding Machine POWER PLAN PP: Material distribution and perfect screeding all in one go.

Whether sub base, base or bedding material, or even dry concrete, the POWER PLAN PP screeds it all to the absolute right level.

Depending on height profile and kind of control system used, it is possible to screed per day between 2.500 sqm (27,000 sqft) using sonic control or up to 10.000 sqm (107,500 sqft) using laser control feature

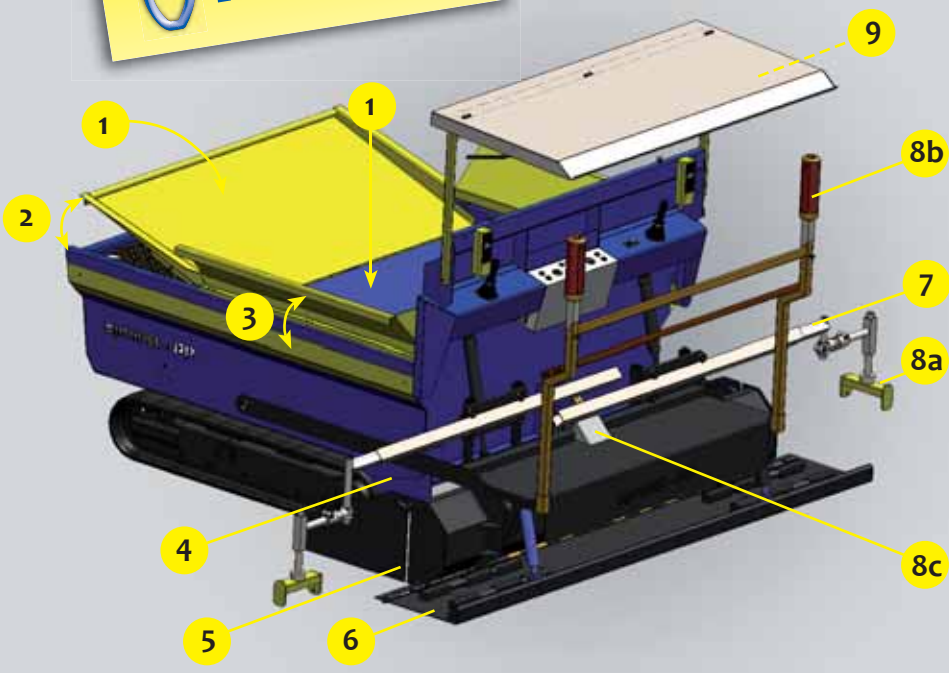

Transportation dimensions:
height 1,900 mm (75")
widths 2,050 mm (81")
length 3,400 mm (135")
weight 2,600 kg (6966 lbs)

- 1 Fast loading by machine from the front or side of the hopper with a maximum 2500mm (98") bucket
- 2 Front of hopper hydraulically operated
- 3 Adjustable hopper sides
- 4 Separately controlled left and right hopper exit flap
- 5 Screeding profile working width adjustable between 2,050 mm (81") and 2,550 mm (100")
- 6 Smoothing boards extensions width between 2,750 (108") – 3,450 mm (135")
- 7 Precision, smooth adjustable holder for the sensors which are infinitely variable according to the working width between 2,100 mm (83") and 6,500 mm (256")
- 8 Height control option via:
 - a.) ultrasound sensors
 - b.) laser sensors
 - c.) inclination sensor
- 9 Weather protection roof (optional)

Telescope Screeding Bucket TAK – One Pull and you are done!

Big areas that are going to be block paved need to be screeded. To do this most efficiently and profitably the process needs to be mechanised, this requires high-performance products. Therefore Probst invented the Telescope Screeding bucket TAK. The system

consists of two side roller units which are adjustable in height attached to special aluminium profile components. Thanks to the robust and extremely rigid design the aluminium profile is telescopic with an easily adjusted working width between

1200 -7500mm (47,24" - 295,28"). Several options are available for special applications and profiles. This means that very large areas can be set out and screeded very easily with just one pull of the machine. Probst makes you process very efficient, saves time and money!

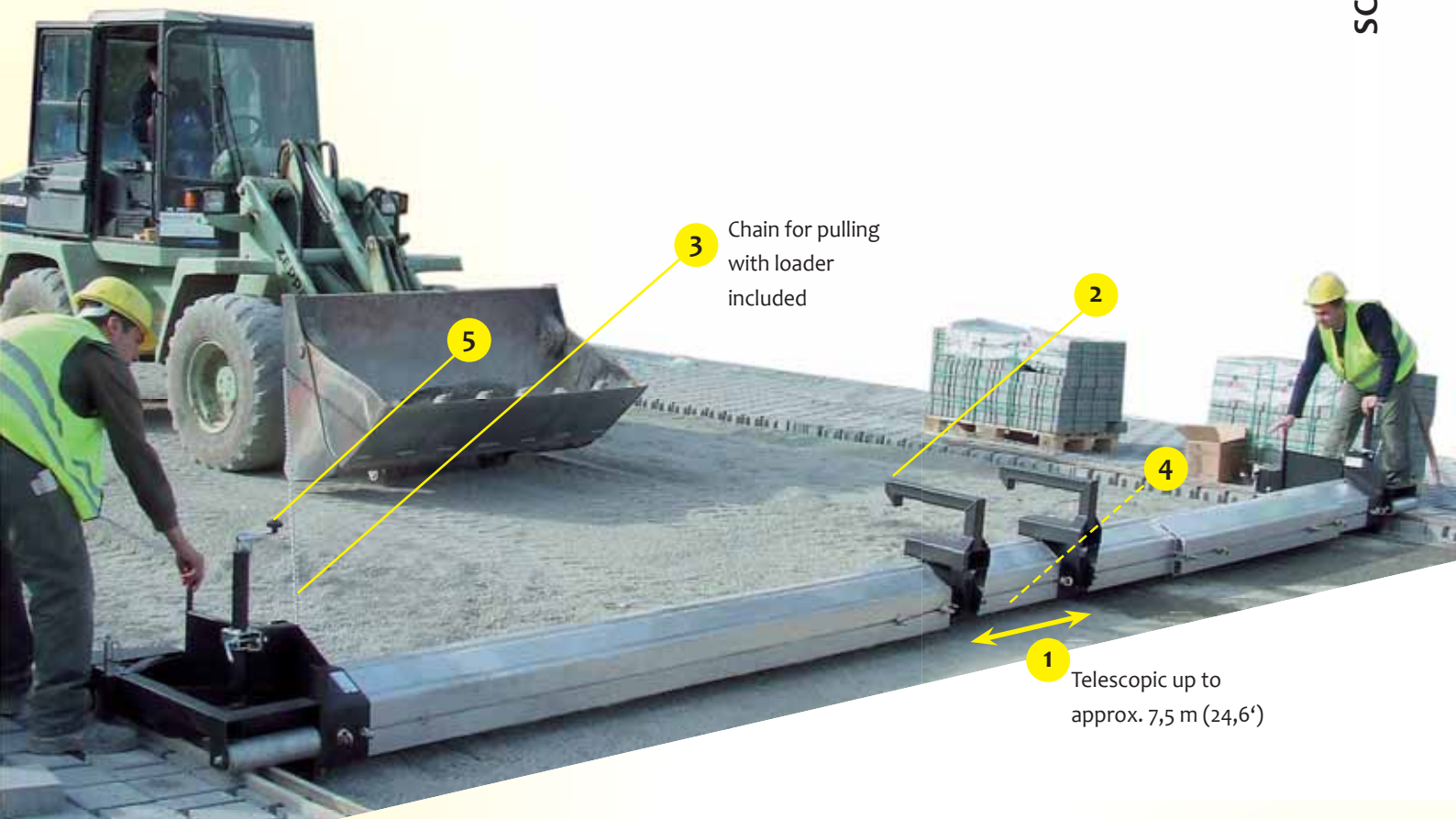

3 Chain for pulling with loader included

5

2

4

1 Telescopic up to approx. 7,5 m (24,6')



2 Lifting device so can be picked up with forks or loading shovel



5 Height adjustable rollers (0-250mm)(0 - 98,43") including ruler for adjustment and scraper for cleaning screeding profile/kerbs



4 Adjustable adaptor TAK-DP(+/-3%) for roof and pan profiles

Telescope Screeding System TAS -uni: The universal all rounder for large and small construction sites!

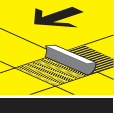

SCREEDING

Well thought out and highly flexible, that's why TAS-uni with its working range from 750 to 6000 mm is ideal for small and large construction sites. Additionally the Probst TAS-uni is lightweight and therefore just one user is required to use it. Thanks to the clever design of high quality aluminium profiles with

protruding cutting groves it keeps enough pressure to the ground regardless if pulled by man or machine. Hence screeding can be done quickly and cleanly in just one operation. The practical technical details like telescopic aluminium profiles and height adjustable side roller units are handy and convincing.

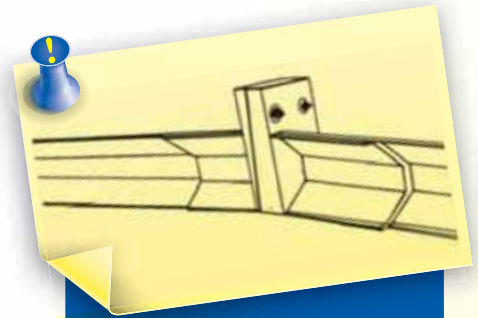

The TAS-DP is a useful supplement for attaching to the TAS-uni Screeding.

The TAS-DP is a useful supplement for enabling the preparation of roof or pan profiles of +/-4%. It is easily and quickly onto the existing TAS-uni profiles. A handy feature is the integrated adjustment indicator with scale to ensure result is exactly as planned.

- 1 The profile height of 280 mm (11") allows to take off and distribute enormous quantities of material
- 2 Telescope design allows easy adjustment of working width between 750 to 6,000 mm (29,5" - 236,22")
- 3 For machine work the chains are included as standard
- 4 Height adjustment via hand crank and roller unit (0 to 250 mm) (0-10")
- 5 Spring loaded sliding metal sheet on the sides
- 6 Side cleaners for profiles/kerbs
- 7 Device for shovel pulling
- 8 Working width adjustment
- 9 Deflectors for height adjustment
- 10 Carrying handles, weight 70kg (150lbs) for 4500mm (177") working width

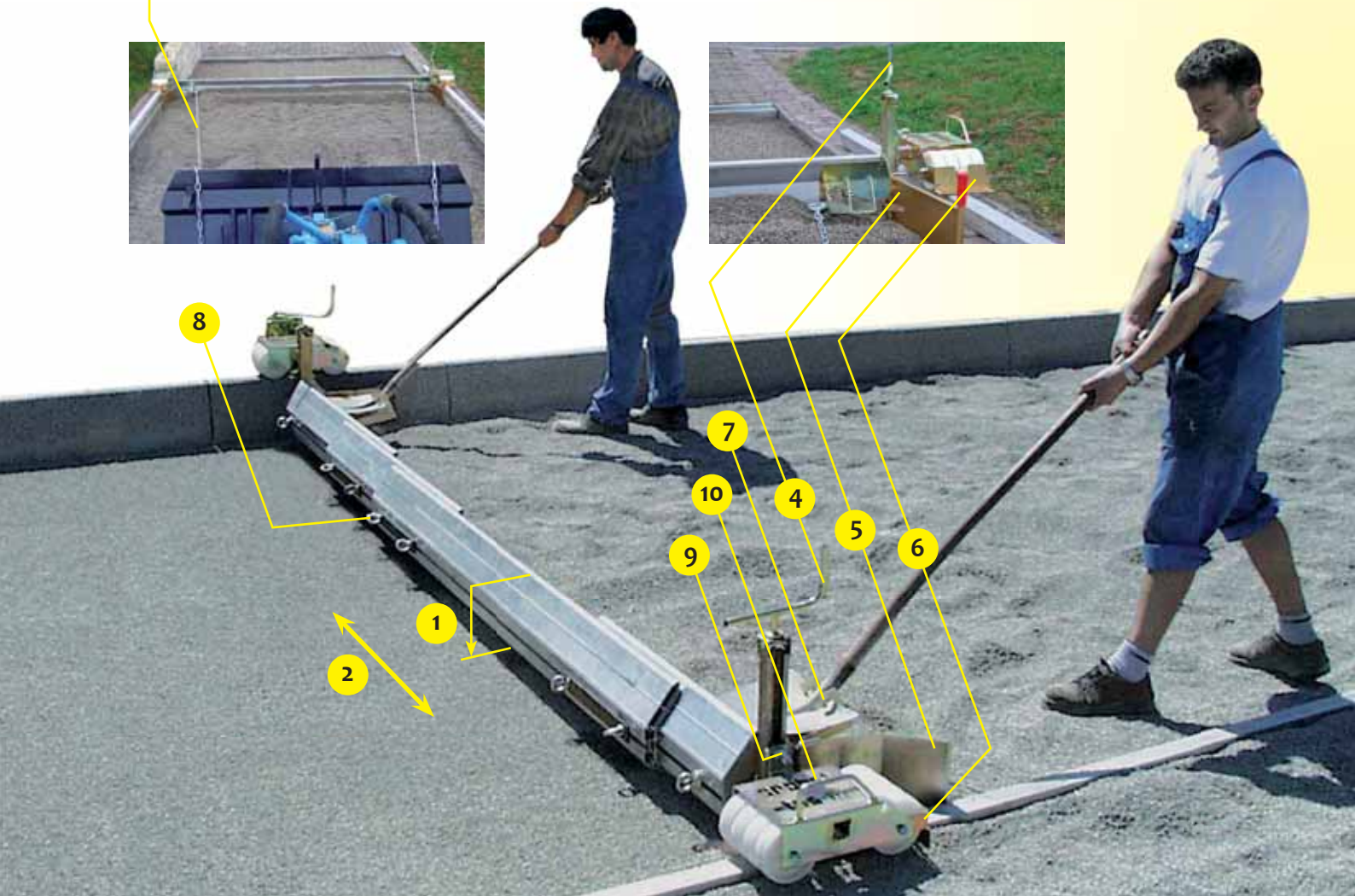
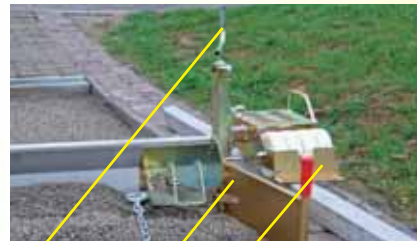

Get up from your knees – with Easy Plan EP-uni System.



Screeding without force just by using your body weight!



- 2** Variable screeding length minimized dead weight, enormously rigid aluminium profile which produces the necessary pressure to the ground. **EP-uni-Set 90/230** telescopic adjustable from 900 to 2,300 mm (35,43" -90,55"), 15kg (33 lbs) in weight **EP-uni-Set 230/300** telescopic adjustable from 2,300 to 3,000 mm (90,55 - 118,11"), 15 kg (33lbs) in weight
- 4** The patented design of the handles gives an optimized ergonomically working position
- 6** Efficient screeding of areas with different inclinations by using standard screed rails (or even better AZL-EP P.8)



3 Option available: Height adjustable roller units for EP-uni to adjust the screeding height from kerb stones or paving blocks



5 Foldable, compact transportation measurements

Wet knees, pain in the back when screeding – never again!

- z Output increase of 300 % possible
- z best for small and medium sized sites

Three times faster, more flexible, ergonomically for the back Tele Plan Handscreeding System TP - the smart solution



TP 150/260 mit HG-TP

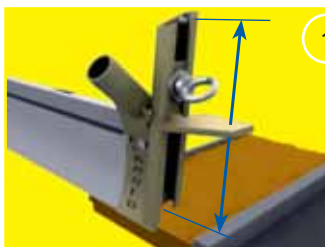

1 Height adjustable arm and holder for handle as standard



2 Sickle shaped profile requires low working force as it doesn't tend to lift upwards



3 Integrated level indicator

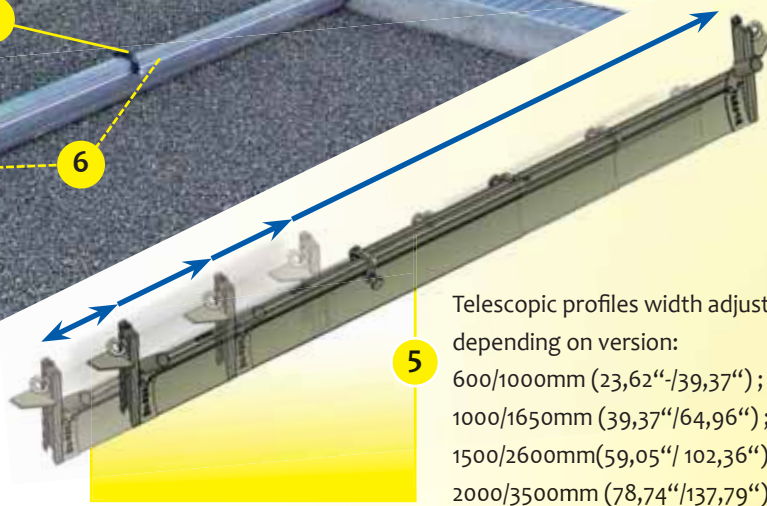

5 Telescopic profiles width adjustment depending on version:
600/1000mm (23,62"/-/39,37");
1000/1650mm (39,37"/64,96");
1500/2600mm (59,05"/102,36");
2000/3500mm (78,74"/137,79")

Output increase of 300% possible!

- z Universal tool for small and medium size job sites
- z The very rigid aluminium profile is still light weight and very handy, e.g. TP 150/260 weights just 6 kg (13,23lbs)
- z All steel parts are galvanized

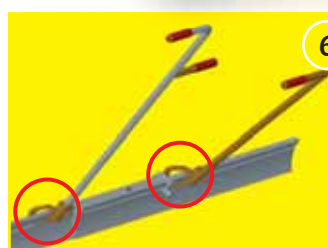

6 Additional single Handle for single operator HG-TP (optional)

Small, handy and very effective – MP 70 Mini-Plan.

Small and handy, however a smart complement even for bigger job sites. With the MP 70 one can e.g. distribute material, screed, minor adjustments and lots more. The super light weight aluminium profile (700mm (27,56“) long) is easy to handle and supports your daily work.

Using the HV attachment (optional) at the MP one can easily do finishing work e.g. screeding around gullies or pipes. Just adjust the height difference at the tool and done! (HV attachment optional left or right fixable).

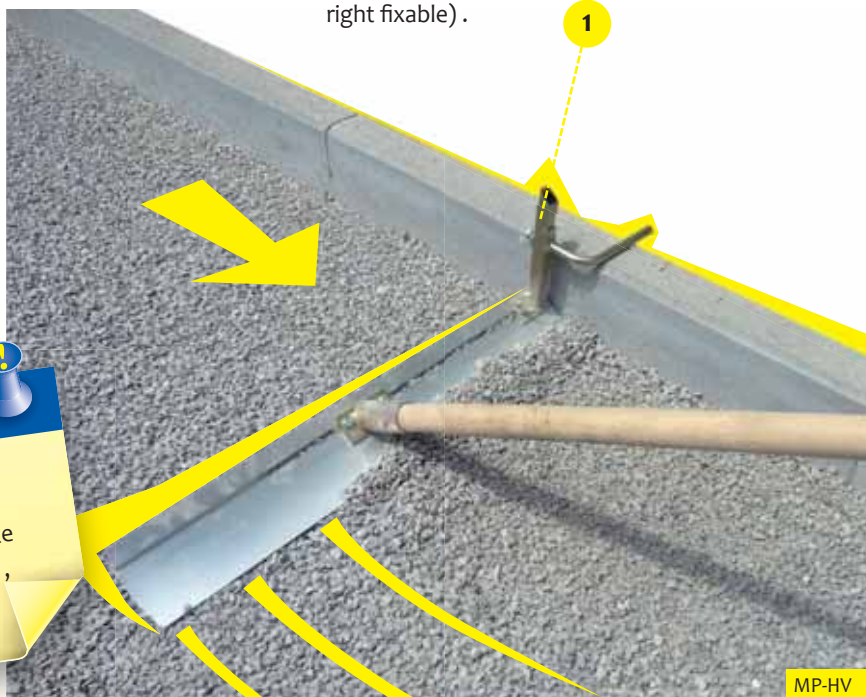

Ideal for:

- z little adjustments
- z filling in screed pole holes
- z connection to the screeding face
- z supporting work, hill side work, finishing work



SCREEDING

A great choice! Probst AZL – robust, practical, well thought out!



z Guided by the screed surface, no guide rails need, hence no additional work

z Extremely rigid & stable aluminium profiles (60 x 60 mm) (2,36“x 2,36“)



z Positioned in the laying material, the upper edge is the screeding level

Patented and practical!

- z tapered connectors, no twisting and misalignment
- z integrated connectors
- z various sets available

World wide No. 1 Supplier of Handling and Laying Systems. Probst is the bench mark in terms of performance, quality, efficiency and profitability.....

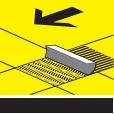

SCREEDING



... paving: Innovative, high performing and flexible – the new and comfortable laying machine VM 401.



...laying big and heavy plates: Powerful and save even with porous material - Vacuum lifter QUICKJET QJ 600-e.



... brushing material in to the joints of the paving: the powerful Easy-Fill EF-H.



... pavement cleaning device: The professionals choice Easy-Clean EC 60.



... laying of kerb stones: The smart choice with numerous advantages: With a standard trailer anywhere at any time - TRANS MOBIL TM.



... the vacuum laying machine: Safe, quick and efficient - Jumbo BV-vario.

From the practice - to the practice!

Probst is well-known for customer-oriented and comprehensive solutions. Significant and profound technical expertise combined with customers' experiences throughout the most

versatile fields of application - this is how we strengthen the market potential and commercial value of our products. The results are robust and field-proven machines, devices and

tools featuring longevity and economic efficiency -thus setting standards for an entire industry sector. For good reasons they say: Probst – the better solution.

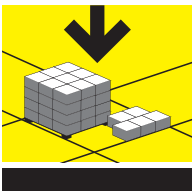

Paver laying and transportation

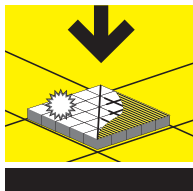

Joint filling and surface cleaning

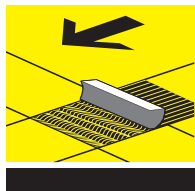

Screeding

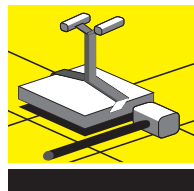

Professional tools

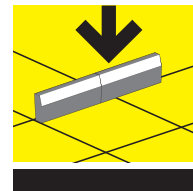

Laying of kerb stones

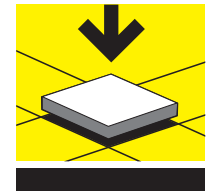

Laying of slabs

Call us for detailed brochures or visit our website.



Probst Greiftechnik Verlegesysteme GmbH
 Gottlieb-Daimler-Straße 6, 71729 Erdmannhausen, Germany
 Telefon +49 7144 3309-0, Telefax +49 7144 3309-50
 info@probst.eu

Our Branch in United Kingdom:

Probst Handling and Laying Systems
 Unit C 12, Wem Industrial Estate
 Soulton Road, Wem, Shropshire, SY4 5SD
 Phone 01939-235325 • Fax 01939-235562
 info@probst-handling.co.uk
 www.probst-handling.co.uk

Specification without obligation, subject to change without prior notice.

Art.-Nr. 29020317 / PAK 3 / 0211 Printed in Germany